

LAVATHERM T57830

Condensation dryer

User Information

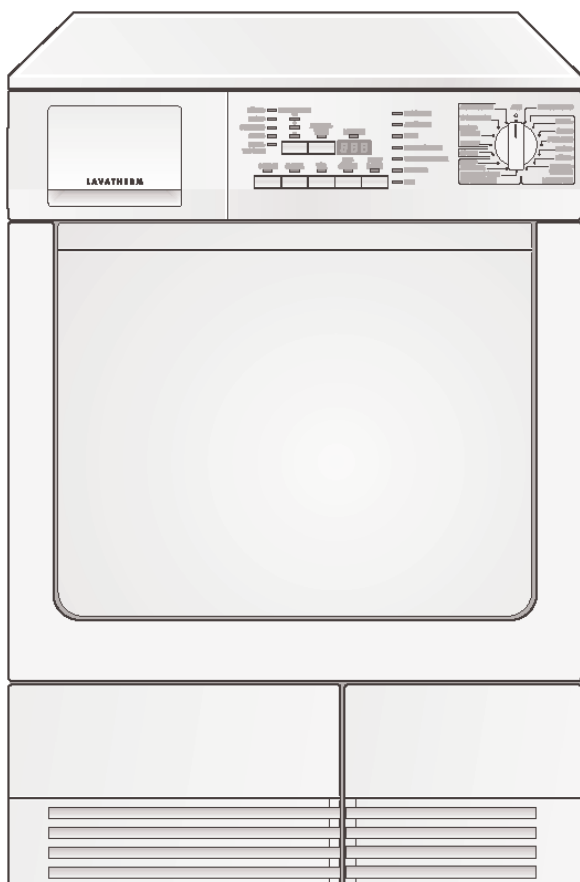

PERFEKT IN FORM UND FUNKTION

AEG
Electrolux

Dear customer,

Please read these operating instructions carefully and pay particular attention to the safety notes indicated in the first pages. We recommend that you keep this instruction booklet for future reference and pass it on to any future owners.



The warning triangle and/or the key words (Warning!, Caution!) emphasize information that is particularly important for your safety or correct functioning of the appliance.



This symbol guides you, step by step, in the operation of the appliance.



The information marked with this symbol provides additional instructions and practical tips on the use of the appliance.



Tips and information about economical and ecological use of the machine are marked with the clover symbol.

Should any problems arise, this booklet provides instructions on how to solve them by yourself; see section "Something not working?".

If this information is not sufficient, please contact our nearest Service centre (address and telephone numbers are indicated on the enclosed leaflet).

Printed on recycled paper.
People who think ecologically, act accordingly...

Contents

Operating Instructions.	4
Safety	4
Disposal	6
Environmental tips.	7
Description of machine.	8
Operating screen	8
Before the first drying cycle	9
Sorting and preparing laundry	9
Overview of programmes	10
Hints & Tips on Drying	12
Drying	14
Switching machine on / switching light on	14
Opening loading door / loading laundry	14
Selecting the programme	14
Selecting additional functions	14
Setting time delay	15
Starting the programme	15
Changing programme	15
Removing laundry or loading laundry when necessary	16
Drying cycle complete / removing laundry	16
Cleaning and maintenance	17
Cleaning lint filter	17
Cleaning the door seal	18
Emptying the water reservoir	19
Cleaning heat exchanger	20
Cleaning the drum	21
Clean operating screen and housing	21
What to do if....	21
Troubleshooting by yourself	21
Changing bulb for inside light	23
Programming options.	24
Technical data.	25
Consumption values.	25
Installation and connection instructions.	26
Installation safety instructions.	26
Removing transport safety equipment.	27
Electrical connection	27
Permanent connection	28
Door reversal instructions	29
Special accessories	30
Warranty conditions.	31
Service and Spare Parts.	32

Operating Instructions

Safety

Before first starting up

- Note the "Installation and connection instructions"
- Before first starting up, check the machine for any damage incurred during transport. Never connect up a damaged machine. If parts are damaged, contact your supplier.

Intended use

- The dryer is intended for drying standard laundry in domestic applications.
- Conversions or modifications to the dryer are not permitted.
- The laundry must not contain flammable solvents (benzene, alcohol, stain remover, etc.) . Risk of fire and/or explosion! Laundry which has come into contact with such substances must be rinsed thoroughly by hand before drying.
- When using dry-cleaning sets: Only use those products which are declared as suitable for the dryer by the manufacturer.
- Do not place items of laundry in the dryer which contain foam rubber or materials similar to rubber. Risk of fire!
- Do not place heavily worn laundry items in the dryer. Risk of fire!
- Do not place laundry items with loose fillings (e.g. cushions) in the dryer. Risk of fire!
- Parts with rigid components (e.g. door mats) may cover the air slots. Risk of fire! Do not place such items in the dryer.
- Do not overfill the dryer. Risk of fire! Observe max. loading volume of 7 kg.
- Ensure that explosive objects (e.g. cigarette lighters, spray cans, etc.) do not enter the dryer with the laundry. Risk of fire and/or explosion!
- Risk of fire: items that have been spotted or soaked with vegetable or cooking oil constitute a fire hazard and should not be placed in the tumble dryer.
- If you have washed your laundry with stain remover you must execute an extra rinse cycle before loading your tumble dryer.
- Clean the micro-fine filter and fine strainer after each drying cycle.
- Do not use the machine if there are no lint filters or if these are damaged. Risk of fire!
- Clean the heat exchanger regularly.
- With stacked washer and dryer: Do not place objects on the dryer. These may fall off during operation.
- The covering bonnet of the bulb for the drum light must be screwed down tightly.

Child safety

- Keep packaging away from children. Risk of suffocation!
- Children can often not see the dangers associated with electric machines. Never leave unsupervised children near the dryer.
- Ensure that children and small animals cannot climb into the dryer's drum. Risk of death! Keep the dryer door shut whenever it is not being used.

General safety

- Only specialists may undertake repairs on the dryer.
- Never start up the dryer if the mains cable is damaged or if the operating screen, operating plate or base area are damaged so that the inside of the machine is open and accessible.
- Switch off the dryer before all cleaning, care or maintenance work. Also disconnect the mains plug from the socket or – with permanent connections – switch off the LS switch in the fuse box and/or fully unscrew the screwed-in fuse.
- Disconnect the machine from the power supply during long pauses in operations.
- When removing from the socket, never pull the mains plug by the cable, instead take a hold of the plug.
- Manifold plugs, couplings and extension cables must not be used. Risk of fire from overheating!
- Do not spray down the dryer with jets of water. Risk of electric shock!
- Do not lean on the open door. The machine may tip over.
- Once the drying cycle has been interrupted, the laundry and drum may be hot. Risk of burns! Take care when removing the laundry.



Disposal

Packaging material

The packaging materials are environmentally friendly and can be recycled. The plastic components are identified by markings, e.g. >PE<, >PS<, etc. Please dispose of the packaging materials in the appropriate container at the community waste disposal facilities.



Old appliance

The symbol  on the product or on its packaging indicates that this product may not be treated as household waste. Instead it shall be handed over to the applicable collection point for the recycling of electrical and electronic equipment. By ensuring this product is disposed of correctly, you will help prevent potential negative consequences for the environment and human health, which could otherwise be caused by inappropriate waste handling of this product. For more detailed information about recycling of this product, please contact your local city office, your household waste disposal service or the shop where you purchased the product.



Warning! Remove mains plug from socket when you have no further use for the machine. Cut off mains cable and dispose of together with plug.

Destroy loading door lock. Children cannot then lock themselves in the machine and put their lives at risk.



Environmental tips

- In the dryer, laundry becomes fluffy and soft. Fabric softeners are not therefore needed when washing.
- Your dryer will function most economically if you:
 - always keep the ventilation slots on the base of the dryer unobstructed;
 - use the loading volumes specified in the programme overview;
 - ensure you have good ventilation in the installation room;
 - clean the micro-fine filter and fine strainer after each drying cycle;
 - spin the laundry well before drying. Example: Consumption data – depending on spinning speed – for 7kg of laundry, dried using the COTTONS STORAGE DRY (KATOEN KASTDROOG) programme.

Revolutions per minute	Pre-draining		Drying cycle	
	in litres		Energy in kWh	Costs in euros ¹⁾
	in liters	as a %		
1000	4,2	60	3,95	0,59
1200	3,9	53	3,69	0,55
1400	3,5	50	3,59	0,53
1800	2,9	42	3,19	0,47

1) Tariff: 0.15 Euro/kWh

Description of machine

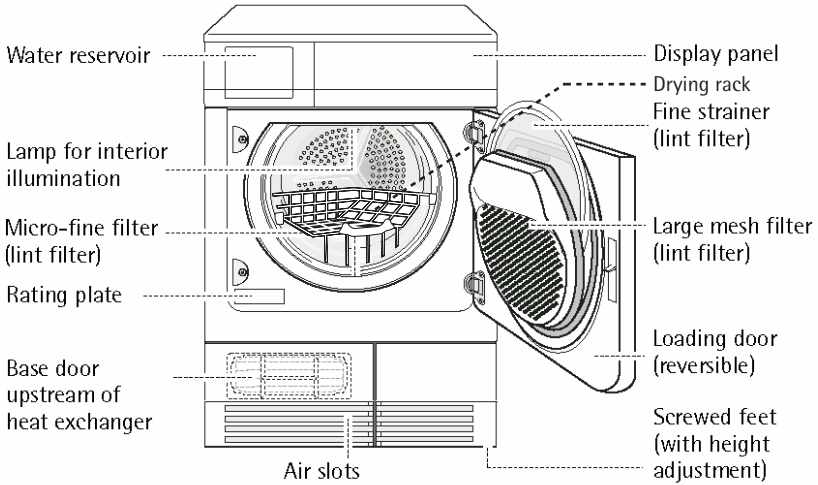

Operating screen

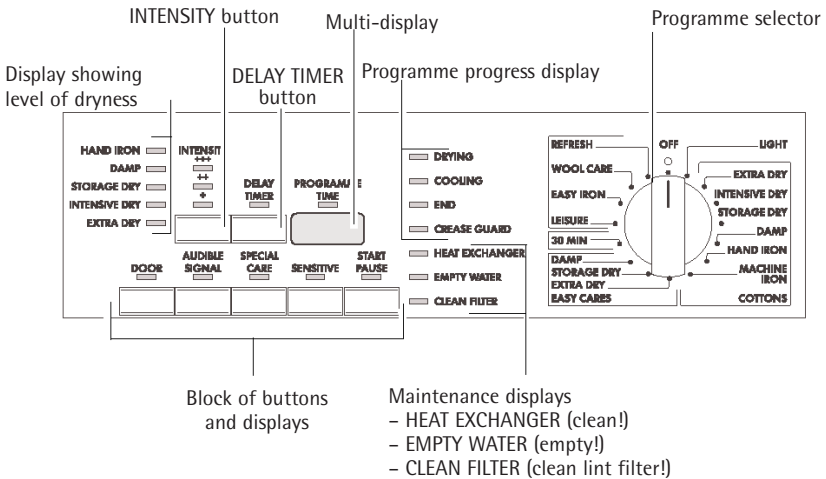





Before the first drying cycle

In order to remove any residue which may have been produced during production, wipe the dryer drum with a damp cloth or undertake a brief drying cycle (30 MIN) with damp cloths.

Sorting and preparing laundry

Sorting laundry

- Sort by fabric type:
- Sort by fabric type:
 - Cotton/linen for programmes in COTTONS programme group.
 - Mixtures and synthetics for programmes in EASY CARES programme group.
- Sorting by care label. The care labels mean:





















			
Basic drying in tumble dryer possible	Drying at normal temperature	Drying at reduced temperature (press SPECIAL CARE button!)	Drying in tumble dryer not possible

- Do not dry new, coloured textiles together with light-coloured laundry items. Textile colours may bleed.
- Do not dry tricot or knitted items with the EXTRA DRY programme. Items may become stuck!
- Do not dry wool in the dryer. May become entangled! After air-drying, wool may be dried with the WOOL CARE programme.

Preparing laundry



- To avoid laundry becoming tangled: Close zips, button up coverings and tie loose bands or ribbons (e.g. of aprons).
- Empty pockets. Remove metallic items (paperclips, safety pins etc).
- Turn items with double-layered fabrics inside out (e.g. with cottonlined anoraks, the cotton layer should be outermost). These fabrics will then dry better.

Overview of programmes

Programme	max. loading volume (weight when dry)	Additional functions				Application/properties	Care symbols	
		SPECIAL CARE	AUDIBLE SIGNAL	SENSITIVE ¹⁾	INTENSITY			
COTTONS	EXTRA DRY	7 kg	•	•	•	•	Drying thick or multi-layered textiles, e.g. terry towelling items, bathing costumes.	 
	INTENSIVE DRY	7 kg	•	•	•	•	Drying thick textiles, e.g. terry towelling items, towels.	 
	STORAGE DRY	7 kg	•	•	•	•	Drying textiles of even thicknesses, e.g. terry towelling items, knitted items, towels.	 
	DAMP	7 kg	•	•	•	•	For thin textiles which are still to be ironed, e.g. knitted items, cotton shirts.	 
	HAND IRON	7 kg	•	•	•	•	For normal thickness cotton or linen laundry, e.g. bedding, table linen.	 
	MACHINE IRON	7 kg	•	•	•	•	For cotton or linen laundry which are still to be put through a machine, e.g. bedding, table linen.	 
EASY CARES	EXTRA DRY	3 kg	•	•	•	•	Drying thick or multi-layered textiles, e.g. pullovers, bedding, table linen.	  ²⁾ 
	STORAGE DRY	3 kg	•	•	•	•	For thin textiles which are not ironed, e.g. easy care shirts, table linen, baby's clothes, socks, corsetry.	  ²⁾ 
	DAMP	3 kg	•	•	•	•	For thin textiles which are still to be ironed, e.g. knitted items, cotton shirts.	  ²⁾ 

1)SPECIAL CARE and SENSITIVE cannot both be selected at the same time.

2) Press the SPECIAL CARE button!

Programme	max. loading volume (weight when dry)	Additional functions				Application/properties	Care symbols
		SPECIAL CARE ¹⁾	AUDIBLE SIGNAL	SENSITIVE ¹⁾	INTENSITY		
30 MIN	1 kg	•	•	-	-	For drying individual items of laundry or for small volumes of less than 1kg.	 ²⁾
LEISURE	7 kg	•	•	•	•	Special programme for leisure clothing, such as jeans, sweat-shirts, etc., of different material thicknesses (e.g. at the cuffs and seams).	
EASY IRON	1 kg	•	•	-	-	Special programme with anti-crease mechanism for easy care textiles such shirts and blouses; for minimum ironing effort. The result depends on the type and quality of textiles. (The loading volume corresponds to approx. 5 to 7 shirts.) Recommendation: Place textiles in the dryer straight after spinning. Once dried, immediately remove textiles and place on clothes hanger.	 ²⁾
WOOL CARE	1 kg	•	•	-	-	Special programme for briefly treating woollens with warm air after they have been dried naturally, worn or stored for long periods. Wool fibres are aligned and the wool becomes soft and snugly. Recommendation: Remove textiles immediately after drying.	
REFRESH	1 kg	•	•	-	-	Special programme, lasting around 35 minutes, for refreshing or gently cleaning textiles with commercially available dry cleaning sets. (Only use those products which are declared as suitable for the drier by the manufacturer; please observe the manufacturer's instructions for use.)	

1)SPECIAL CARE and SENSITIVE cannot both be selected at the same time.

2) Press the SPECIAL CARE button!

Hints & Tips on Drying

Before placing articles of laundry in your tumble dryer, check the care labels to ensure they are recommended for tumble drying.

Here is a list of the approximate weight of some common laundry items.:

Sheet	700 to 1000 g
Pillowcase	100 to 200 g
Tablecloth	400 to 500 g
Table Napkin	50 to 100 g
Kitchen Towel	70 to 120 g
Linen Hand Towel	100 to 150 g
Hand Towel	150 to 250 g
Bath Towel	700 to 1000 g
Bathrobe	1000 to 1500 g
Shirt	200 to 300 g
Apron	150 to 200 g

- Always load well spun laundry. The higher the spin speed the lower the electricity consumption and the shorter the drying time.
- DO NOT load dripping wet laundry into the dryer. Roll the article in a towel or spin to remove excess water.
- Close poppers and zips and fasten any buttons.
- Sort the laundry. Separate synthetics from cotton/linens, and dry separately.
- Remove the laundry immediately after the programme has finished.
- Use a fabric conditioning sheet to reduce static. We recommend the sheet is pinned to an article of laundry (using a safety pin).
- Mix the load i.e. large and small articles.
- When drying large items such as sheets, we recommend you periodically stop the dryer to redistribute the load.

DO NOT use the tumble dryer to dry the following:

- Articles contaminated with inflammable substances e.g. petrol, cleaning solvents, cooking oil, fats or hair lacquer.
- Woollen and synthetic/wool mixtures unless the item is labelled as suitable for tumble drying.
- Very delicate articles such as silk.
- Very large and bulky items such as duvets or sleeping bags.

Drying

Switching machine on / switching light on

Turn the programme selector to any programme or turn it to LIGHT. The machine has been switched on. When the loading door is opened, the drum is illuminated.

Opening loading door / loading laundry

1. Open loading door:

Use force to push against the loading door (push point )

2. Load your laundry (do not force it in).



Caution! Do not jam laundry in between the loading door and rubber seal.

3. Close loading door securely. Lock must audibly lock.

Selecting the programme

Use the programme selector to set the programme you require.

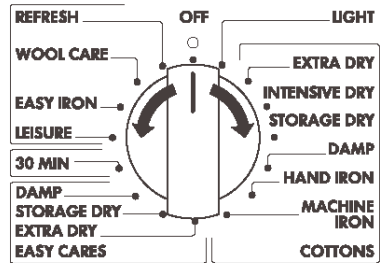

Selecting additional functions

INTENSITY

Precise setting of humidity content of laundry. Laundry becomes dryer from + to +++.

1. Press the INTENSITY button as many times as necessary until the small light at the level of residual dampness required is illuminated.

If required, press the AUDIBLE SIGNAL, SPECIAL CARE or SENSITIVE buttons.

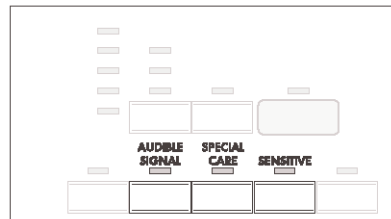
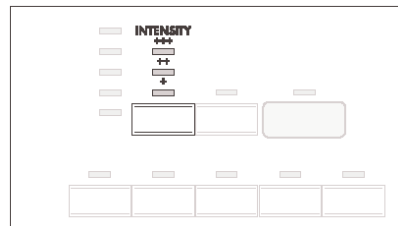

AUDIBLE SIGNAL

When the drying cycle has finished, an intermittent audible signal will sound.

SPECIAL CARE

For especially gentle drying of sensitive fabrics with the  care label and for temperature-sensitive textiles (e.g. acrylic, viscose). Programme is executed with reduced heat.

SPECIAL CARE is only suitable for use with loads of up to 3 kg!

SENSITIVE

For gentle drying of frequently-worn textiles. Programme starts on full heat setting, which is then reduced towards the end of the programme to ensure gentle care of laundry.



SPECIAL CARE and SENSITIVE cannot be selected together.

Setting time delay



With the DELAY TIMER button, you can delay the start of a programme by between 30 minutes (30') and a maximum of 23 hours (23H).

1. Select the programme
2. Press the DELAY TIMER button as many times as necessary until the required start delay appears on the multi display, e.g. 12h if the programme is to be started in 12 hours. The DELAY TIMER display is illuminated.



If 23H is displayed and you press the button again, the time delay will be cancelled. The display will show 0' and then the duration of the selected programme.

3. To activate the delay timer, press the START/PAUSE button. The amount of time remaining until the programme is set to start is continuously displayed (e.g. 12H, 11H, 10H, 30' etc).



Until the start of the programme the drum is moved at longish intervals to loosen the laundry

Starting the programme

Press the START/PAUSE button. The programme is started.

The programme progress display and the display showing the level of dryness show drying progress.

Changing programme

To change a programme which has been selected by mistake once the programme has started, first turn the programme selector to OFF and then reset the programme.



The programme can no longer be changed directly once the programme has started. If nevertheless there is an attempt to change the programme on the programme knob, the programme progress display and the maintenance indicators flash. If an option button (excluding the AUDIBLE SIGNAL button) is pressed, the corresponding indicator flashes several times. The drying programme is not however affected by this (laundry protection).

Removing laundry or loading laundry when necessary

1. Open loading door



Warning! Laundry and drum can become hot. Risk of burns!

2. Load or remove laundry items.
3. Close loading securely. Lock must audibly lock.
4. Press the START/PAUSE button to continue the drying cycle.

Drying cycle complete / removing laundry

Once the drying cycle is complete, the END and CREASE GUARD displays light up. If the AUDIBLE SIGNAL button has been pressed, an audible signal sounds intermittently.



The drying cycle is automatically followed by a crease guard phase which lasts around 30 minutes. The drum rotates in intervals during this phase. The laundry thereby remains relaxed and free of creases. The laundry can be removed at any time during the crease guard phase. (The laundry should be taken out towards the end of the crease guard phase at the latest to prevent creases from forming.)

1. Open loading door
2. Before removing the laundry, remove lint from the micro-fine filter. It is best to use a damp hand for this purpose (refer to "Cleaning and maintenance" section).
3. Remove laundry.
4. Turn the programme selector to OFF.

Important! After each drying cycle

- clean the micro-fine filter and fine strainer,
- drain the condensate tank

(refer to the "Cleaning and maintenance" section).

5. Close loading door.

Cleaning and maintenance

Cleaning fluff filter

To ensure that the dryer works perfectly, the fluff filters (micro-fine filter and fine strainer) must be cleaned after every drying cycle.



Caution! Never operate the dryer without fluff filters or with damaged or blocked fluff filters.

1. Open loading door
2. Use a damp hand to clean the micro-fine filter, which is built into the lower part of the loading aperture.

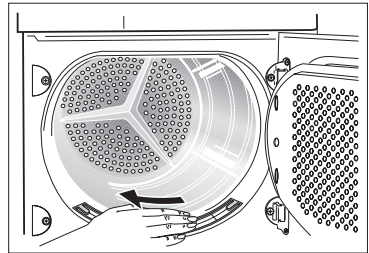

3. Push down unlock button on large mesh filter. Large mesh filter jumps up.

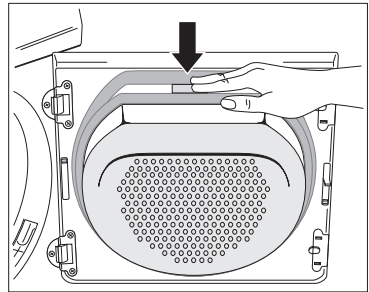

4. Take out fine strainer.
5. Remove fluff from fine strainer. It is best to use a damp hand for this purpose.

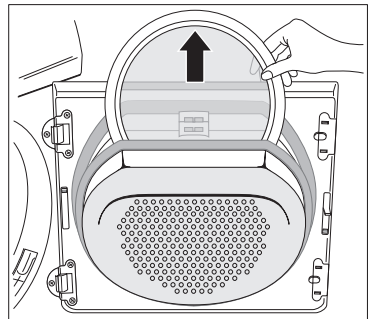



Clean the entire filter area

The strainer area does not have to be cleaned after every drying cycle, but should be checked regularly and cleaned of fluff if necessary.

6. To do this, grip the top of the large mesh filter and pull it forwards until it comes loose from the two brackets.
7. Remove fluff from the entire filter area. It is best to use a vacuum cleaner for this purpose.
8. Press both journals of the large mesh filter into the brackets on the loading door until they snap into place.
9. Re-insert fine strainer.
10. Press against the large mesh filter until it locks into the interlock.

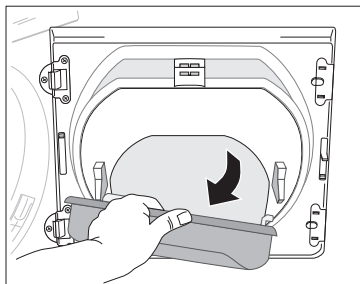

If the fine strainer is not fitted, the large mesh filter will not snap into place and the loading door cannot be closed.

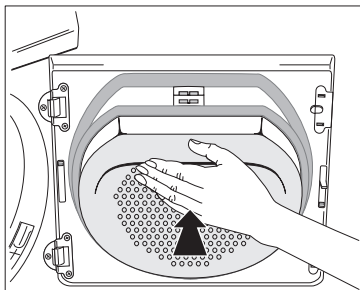

Cleaning the door seal

Wipe the door seal with a damp cloth immediately after the drying cycle has finished.

Emptying the water reservoir

Empty condensate tank after every drying cycle.

If the condensate tank is full, an active programme will break off automatically and the EMPTY WATER display will light up. In order to continue the programme, the condensate tank must first be emptied.



Warning! The condensate is not suitable for drinking or for preparing foodstuffs.

1. Take out drawer containing condensed water container completely (1) and pull up the condensed water container's drainage pipe as far as it will go (2).

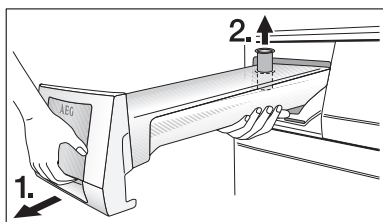

2. Pour condensed water out into a basin or similar receptacle.
3. Slide outlet connections in and refit condensate tank. If the programme has been interrupted as a result of the condensate tank being full: Press the START/PAUSE button to continue the drying cycle.

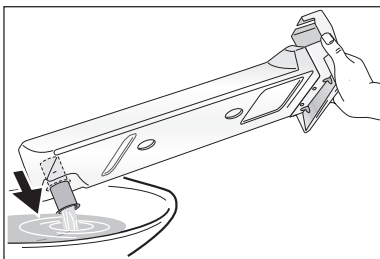

The water reservoir has a volume of approx. 4 litres. This is sufficient for around 7 kg of laundry which has previously been spun at 800 revolutions/minute.



The condensate can be used as distilled water, e.g. for steam ironing. However first filter the condensate (e.g. with a coffee filter) to remove any residue and small pieces of fluff.

Cleaning heat exchanger

If the HEAT EXCHANGER display is illuminated, the heat exchanger needs to be cleaned.



Caution! Operating when the heat exchanger is clogged with lint can damage the dryer. This also increases energy consumption.

1. Open loading door
2. Open base door. To do this, press the release button on the bottom of the loading opening and open the door to the left.
3. Remove lint from the inside of the door and the heat exchange chamber. Wipe the door seal with a damp cloth.
4. Turn both lock washers inward.
5. Use the handle to pull the heat exchanger out of the base and carry it horizontally to prevent any remaining water from spilling.
6. To empty the heat exchanger, hold vertically over a washing-up bowl.

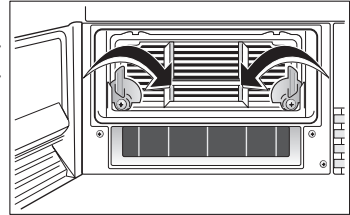
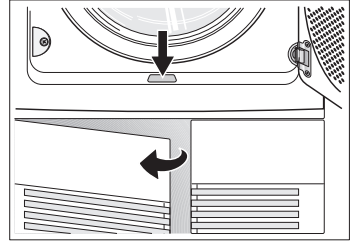

Caution! Do not use sharp objects to clean. The heat exchanger could develop leaks.

7. Clean heat exchanger.
It is best to use a brush or to rinse thoroughly with a shower head.
8. Replace heat exchanger and lock into place (turn both lock washers outwards until they snap into place).
9. Close base door.

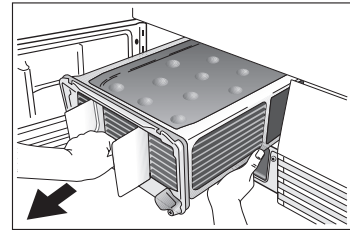

The dryer will not operate if the HEAT EXCHANGER indicator is still lit.



Caution! Never operate the dryer without the heat exchanger.

Cleaning the drum



Caution! Do not use abrasives or steel wool to clean the drum.



Lime in the water or cleaning agents may form a barely visible lining on the inside of the drum. The degree to which the laundry has been dried is then no longer detected reliably. The laundry is damper than expected when removed from the dryer.

Use a standard domestic cleaner (e.g. vinegar-based cleaner) to wipe down the inside of the drum and drum ribs.

Clean operating screen and housing



Caution! Do not use furniture cleaners or aggressive cleaning agents to clean the machine.

Use a damp cloth to wipe down the operating screen and housing.

What to do if ...

Troubleshooting by yourself

If, during operation, the error code (E plus number or letter) appears on the multi-display: Switch the machine off and on again. Reset programme. Press the START/PAUSE button

If the error is still displayed, please inform your local Service Force Centre and quote the error code.

Problem	Possible cause	Remedy
Dryer does not work.	Mains plug is not plugged in or fuse is not working correctly.	Plug in at mains socket. Check fuse in fuse box (domestic installation).
	Loading door is open.	Close loading door.
	Have you pressed the START/ PAUSE button?	Press the START/PAUSE button again.

Problem	Possible cause	Remedy
Drying results unsatisfactory.	Wrong programme selected.	Select a different programme the next time you dry (see "Overview of programmes" section).
	Lint filter clogged.	Clean lint filter.
	Heat exchanger clogged with lint.	Clean heat exchanger.
	Overloading of laundry.	Observe recommended loading volumes.
	Ventilation slots in base area covered up.	Uncover ventilation slots in base area.
	Residue on inside surface of drum or drum ribs.	Clean inside surface of drum and drum ribs.
		Make an adjustment using the INTENSITY function (see chapter "Drying, Selecting additional functions").
Loading door does not open with DOOR button.	Mains plug disconnected.	Plug in at mains socket.
	Programme selector in OFF position.	Set programme. Loading door can be opened at any time by exerting pressure on the door.
Loading door does not close.	Fine strainer not in place and/or large mesh filter not locked in place.	Install fine strainer and/or snap large mesh filter into place.
When pressing a button, the corresponding button flashes several times.	Washing protection. After the start of the programme, the option can no longer be set.	Turn the programme knob to OFF Set the programme again.
Drum light does not work.	Programme selector in OFF position.	Turn programme selector to LIGHT or to any programme.
	Defective light bulb.	Replace light bulb (see next section).
PROGRAMME TIME display changes erratically or stays unchanged for a long time.	Programme time is corrected automatically depending on type and volume of laundry and level of dampness.	Automatic process; this is not a machine fault.
Programme inactive, EMPTY WATER display illuminated.	Condensate tank is full.	Empty condensate tank, then start programme with START/PAUSE button.

Problem	Possible cause	Remedy
Drying cycle lasts an unusually long time. Note: After around 5 hours the drying cycle ends automatically (see „Drying cycle complete“).	Lint filter clogged.	Clean lint filter.
	Heat exchanger clogged with lint.	Clean heat exchanger.
	SPECIAL CARE button pressed and load volume too big.	SPECIAL CARE is only suitable for use with loads of up to 3 kg!
	Load volume too big.	Reduce load volume.
	Laundry insufficiently pre-drained.	Laundry must be adequately pre-drained.
Drying cycle ends shortly after programme starts. END display illuminated.	Not enough washing loaded or washing loaded is too dry for selected programme.	Select time programme or higher drying level (e.g. INTENSIVE DRY instead of STORAGE DRY).

Changing bulb for inside light

Only use a special bulb which is designed specially for dryers. The special bulb is available from the after-sales service, ET-Nr. 112 552 000-5.



Warning! Do not use standard bulbs! These develop too much heat and may damage the machine!



Warning! Before replacing the bulb, disconnect the mains plug; with a permanent connection: fully unscrew or deactivate the fuse.

1. Unscrew covering bonnet from above bulb (this can be found directly behind the loading aperture, at the top; refer to "Description of machine" section.)
2. Replace defective bulb.
3. Screw covering bonnet back down.



Warning! For reasons associated with safety, the covering bonnet must be screwed down tightly. If this is not done, the dryer must not be operated.

Programming options

Objective	Implementation
<p>Permanently programme in the audible signal which reminds you that the programme is complete.</p>	<ol style="list-style-type: none"> 1. Turn the programme selector to any programme. 2. Press the AUDIBLE SIGNAL button and hold down for approx. 5 seconds. A brief signal sounds several times. The AUDIBLE SIGNAL display flashes several times. The setting is permanently programmed. The setting is cancelled as described under 1 and 2.
<p>Adjust "level of dryness" detection: If the laundry is slightly drier or slightly damper at the end of the programme than with the standard setting.</p>	<ol style="list-style-type: none"> 1. Turn the programme selector to any programme. 2. Press the AUDIBLE SIGNAL and SENSITIVE buttons at the same time and hold down for approx. 5 seconds. The current setting appears on the multi-display: <ul style="list-style-type: none"> - D: Setting for drier laundry - T: Standard setting - Z: Setting for damper laundry 3. Press the START/PAUSE button until the setting required appears on the multi-display. 4. Turn the programme selector to OFF. The setting is permanently programmed.
<p>To deactivate the EMPTY WATER display when using an external drain for the condensed water.</p>	<ol style="list-style-type: none"> 1. Turn the programme selector to any programme. 2. Press the DOOR and SPECIAL CARE buttons at the same time and hold down for approx. 5 seconds. The multidisplay briefly displays "D" The EMPTY WATER display is permanently deactivated. The setting is cancelled as described under 1 and 2; the multi-display however briefly displays "7" (rather than "D").

Technical data

This appliance conforms with the following EU Directives:

- 73/23/EEC dated 19.02.1973 Low Voltage Directive
- 89/336/EEC dated 03.05.1989 EMC Directive inclusive of Amending Directive 92/31/EEC
- 93/68/EEC dated 22.07.1993 CE Marking Directive

Height x width x depth	85 x 60 x 60 cm
Depth with loading door open	109 cm
Height can be adjusted by	1,5 cm
Weight when empty	approx. 42kg
Loading volume (depends on programme) ¹⁾	max. 7 kg
Energy consumption in accordance with IEC 1121 s. e. (7 kg of cotton, pre-drained at 1000 rpm, COTTONS STORAGE DRY (KATOEN KASTDROOG) programme)	3,95 kWh
Use	Domestic
Use	+ 5°C à + 35°C

1) Different loading volume data may be needed in some countries as a result of different measuring methods.

Consumption values

The consumption values have been established under standard conditions. They may deviate when the machine is operated in domestic circumstances.

Programme	Loading volume in kg	Energy consumption in kWh
COTTONS STORAGE DRY ¹⁾	7	3,95
COTTONS HAND IRON ¹⁾	7	3,05
EASY CARES STORAGE DRY ²⁾	3	1,45

1) pre-drained at 1000 rpm

2) pre-drained at 1200 rpm

Installation and connection instructions

Installation safety instructions

- Before first starting up, all parts of the transport safety equipment must be removed. The machine may otherwise be damaged.
- Before starting up for the first time, ensure that the nominal voltage and type of current specified on the machine type plate match the nominal voltage and type of current at the installation site. The electrical fuses required can also be found on the type plate.
- Always connect the plug into a protection contact socket which has been installed as specified.
- With permanent connections: A permanent connection may only be established by an authorised specialist electrician.
- Do not install machine in rooms at risk of frost.
- Ensure that the door of the machine cannot be blocked by interior doors of the house or the doors of other appliances.
- Do not install on carpets with high piles. Air circulation will be hindered at the ventilation slots.
- Ensure that the machine is not placed on its mains cable.
- Install the machine horizontally.

Removing transport safety equipment



Caution! Before first starting up, all parts of the transport safety equipment must be removed.

1. Open loading door
2. Pull off adhesive strips from inside machine on top of drum.
3. Remove foil hose and polystyrene padding from the machine.

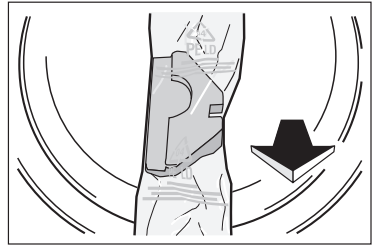
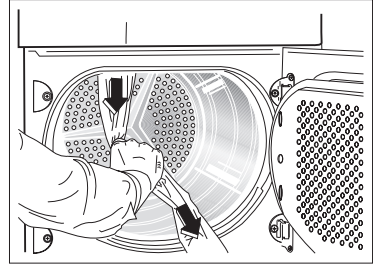

Electrical connection

Any electrical work required to install this appliance should be carried out by a qualified electrician or competent person.



WARNING: THIS APPLIANCE MUST BE EARTHED.

The manufacturer declines any liability should this safety measure not be observed.

Should the appliance power supply cable need to be replaced, this must be carried out by our Service Centre.

Before switching on, make sure the electricity supply voltage is the same as that indicated on the appliance's rating plate. (See picture on page 8).

The appliance is supplied with a 13amp plug fitted.

In the event of having to change the fuse in the plug supplied, a 13amp ASTA approved BS 1363/A fuse must be used.

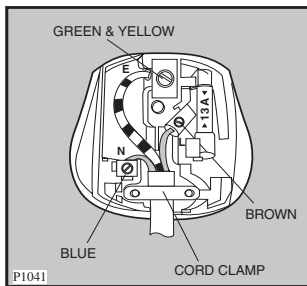

The wire coloured green and yellow must be connected to the terminal marked with the letter «E» or by the earth symbol \perp or coloured green and yellow.

The wire coloured blue must be connected to the terminal «N» or coloured black.

The wire coloured brown must be connected to the terminal marked «L» or coloured red.

Upon completion there must be no cut, or stray strands of wire present and the cord clamp must be secure over the outer sheath.

WARNING:



A cut off plug inserted into a 13 amp socket is a serious safety (shock) hazard.

Ensure that the cut off plug is disposed of safely.



The power supply cable must be accessible after installing the machine.

Permanent connection

In the case of permanent connection it is necessary that you install a double pole switch between the appliance and the electricity supply (mains), with a minimum gap of 3mm between the switch contacts and of a type suitable for the required load in compliance with the current electrical regulations.

The switch must not break the yellow and green earth cable at any point.

Door reversal instructions



Warning! The door stop may only be changed by a specialist. If necessary, please contact our after-sales service or your specialist dealer.

Warning! Before changing the door stop, disconnect the mains plug; with a permanent connection: fully unscrew or deactivate the fuse.

1. Open loading door
2. Unscrew hinge A from the front of the machine and take off the loading door.
3. Remove cover plates B and C. To do this, insert a thin screwdriver into the slots as shown in the illustration, press downwards slightly and pry out the cover plates.
4. Use an appropriate tool and exert pressure to unfasten locking block D from the snap-on fixture, take out and reinsert on the other side, having rotated the block through 180°.
5. Unscrew hinge A from the loading door, rotate through 180°, reinsert on the opposite side and screw down.
6. Reinsert cover plates B and C on the opposite site having first rotated them through 180°.
7. Unscrew cover plates E from the front of the machine, rotate through 180, screw on the opposite side.
8. Unscrew door lock F, push down slightly and remove from the front of the machine.
9. Press snap-in button G in and down, press cover down slightly and remove from front of the machine.
10. Transfer door lock F to the opposite side and screw down.
11. Fix cover G on to the other side and allow the snap-in button to lock in place.
12. Insert loading door and hinges into recesses on the front of the machine and screw down.

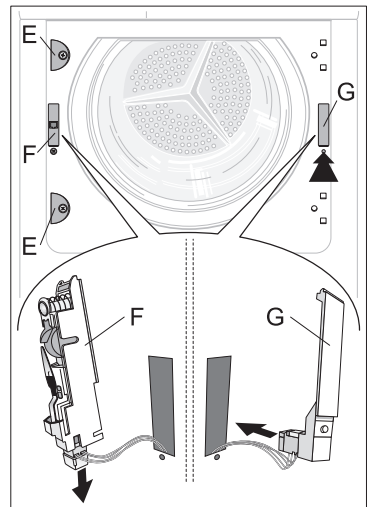
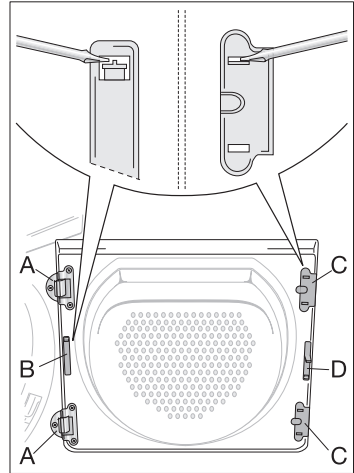

Special accessories

The following special accessories are available from your Service Force Centre or your specialist dealer:

Intermediate installation kits for stacked washer and dryer:

These intermediate installation kits can be used to arrange the dryer and an automatic AEG-Electrolux washing machine (60cm wide, front loading) as a space-saving washer/dryer stack. The automatic washing machine is at the bottom and the dryer is at the top.

Two versions can be supplied:

- without stacker plate 916.018 902
- with extractable stacker plate 916.018 903

Installation kit for external condensate drain

Installation kit (125 122 510) for direct draining of condensate into a basin, siphon, gully, etc. The condensate tank then no longer has to be drained, it must however remain in its intended position in the machine. Refer to the "Programme options" section for how to deactivate the EMPTY WATER display. Max. displacement height: 1m from the base of the dryer; max. displacement length: 3m

Warranty conditions

Great Britain

We, AEG, undertake that if within 12 months of the date of the purchase this AEG appliance or any part thereof is proved to be defective by reason only of faulty workmanship or materials, we will, at our discretion repair or replace the same FREE OF CHARGE for labour, materials or carriage on condition that:

- The appliance has been correctly installed and used only on the electricity or gas supply stated on the rating plate.
- The appliance has been used for normal domestic purposes only, and in accordance with the manufacturer's operating and maintenance instructions.
- The appliance has not been serviced, maintained, repaired, taken apart or tampered with by any person not authorised by us.
- All service work under this guarantee must be undertaken by a Service Force Centre. Any appliance or defective part replaced shall become the Company's property.
- This guarantee is in addition to your statutory and other legal rights.
- Home visits are made between 8.30am and 5.30pm Monday to Friday. Visits may be available outside these hours in which case a premium will be charged.

Exclusions

This guarantee does not cover:

- Damage or calls resulting from transportation, improper use or neglect, the replacement of any light bulbs or removable parts of glass or plastic.
- Costs incurred for calls to put right an appliance which is improperly installed or calls to appliances outside the United Kingdom.
- Appliances found to be in use within a commercial environment, plus those which are subject to rental agreements.
- Products of AEG manufacture which are not marketed by AEG.

European Guarantee

If you should move to another country within Europe then your guarantee moves with you to your new home subject to the following qualifications:

- The guarantee starts from the date you first purchased your product.
- The guarantee is for the same period and to the same extent for labour and parts as exists in the new country of use for this brand or range of products.
- This guarantee relates to you and cannot be transferred to another user.
- Your new home is within the European Community (EC) or European Free Trade Area.
- The product is installed and used in accordance with our instructions and is only used domestically, i.e. a normal household.
- The product is installed taking into account regulations in your new country.

Before you move please contact your nearest Customer Care centre, listed below, to give them details of your new home. They will then ensure that the local Service Organisation is aware of your move and able to look after you and your appliances.

France	Senlis	+33 (0) 3 44 62 29 29
Germany	Nürnberg	+49 (0) 800 234 7378
Italy	Pordenone	+39 (0) 800 117511
Sweden	Stockholm	+46 (0) 8 672 5360
UK	Slough	+44 (0) 1753 219899

From the Electrolux Group. The world's No.1 choice.

The Electrolux Group is the world's largest producer of powered appliances for kitchen, cleaning and outdoor use. More than 55 million Electrolux Group products (such as refrigerators, cookers, washing machines, vacuum cleaners, chain saws and lawn mowers) are sold each year to a value of approx. USD 14 billion in more than 150 countries around the world.

AEG Hausgeräte GmbH
Postfach 1036
D-90327 Nürnberg

<http://www.aeg.hausgeraete.de>

© Copyright by AEG

125985032-01-200606-01